

# Data Sheet



Article number: 1080401071000

Description: Servocontroller ACU401-07-FA  
0,75 kW 2,4A 3x400V IP20

## Measures

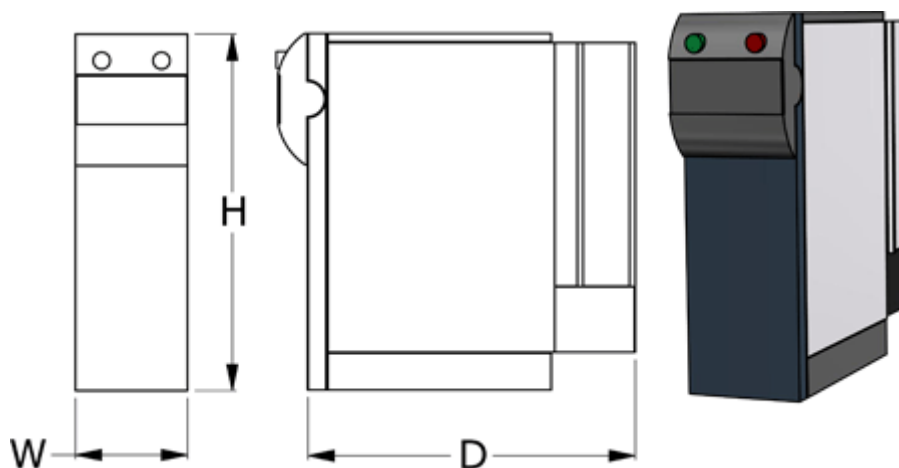

D = 175  
H = 190  
W = 60  
Weight = 1.2